

A close-up photograph of a hand holding a hammer, about to strike a nail. The hammer is silver and has a wooden handle. The nail is silver and is being held in place by the hand. The background is a blurred mix of yellow and blue. The image is overlaid with a large red circle on the left and a large yellow circle on the right, both of which are partially overlapping the text.

# Pregos polidos e galvanizados

Segurança com durabilidade

Uma parceria entre  
ArcelorMittal e Bekaert.

**belgo**  
arames

# Introdução

Especialista em arames, a Belgo Arames é líder reconhecida do mercado brasileiro por investir em qualidade, tecnologia avançada e parcerias de confiança. Com um dos maiores e mais modernos parques industriais do país, a empresa cria soluções para maximizar o negócio de cada cliente.

# Embalagem

Os pregos Belgo Arames são embalados em **sacos plásticos de 1 kg** e acomodados em caixas de **papelão de 20 kg**, exceto os pregos para telhas, que são embalados em **sacos plásticos de 500 g** e **caixas de 10 kg**. Os códigos de barra da caixa e o saco facilitam a identificação do produto.



# Sistema de conversão

Polegadas Inglesas x BWG (Ø) 1 polegada = 25,4mm		
Polegadas (h)		BWG (Ø)
2 1/2"	x	10
↓		↓
(2 1/2" x 25,4mm)		(ver tabela)
↓		↓
63,5mm	x	3,45mm

JP (Ø) x LPP 1 LPP = 2,30mm		
JP (Ø)		LPP (h)
18	x	27
↓		↓
(ver tabela)		(27 x 2,30mm)
↓		↓
3,45mm	x	62,10mm

As medidas utilizadas estão em Polegadas Inglesas x BWG (Birmingham Wire Gauge) e JP (Jauge de Paris) x LPP (Linha de Polegadas Portuguesas).

O mercado utiliza essas duas medidas que apresentam, entre si, uma equivalência aproximada.



As imagens dos pregos deste catálogo representam exatamente o seu tamanho real.

● E sempre que visualizar o círculo vermelho ao lado, é porque também produzimos o modelo na versão galvanizada.





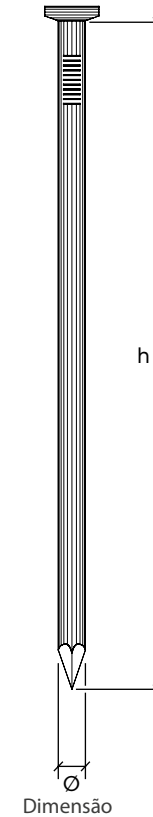





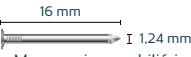

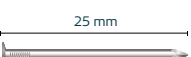

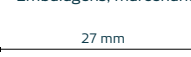
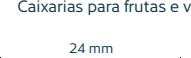
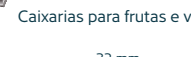
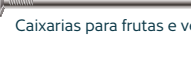
Observação: outras dimensões podem ser fornecidas mediante consulta.

# Características e dimensões



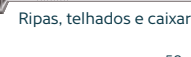

JP (Ø) x LPP (h)	POL. (h) x BWG (Ø)	Dimensão: h (mm) x Ø (mm)	Quant Aprox. em 1 kg
8x7	5/8x18	16x1,24	5710
10x9	3/4x17	19x1,50	3640
10x11	1x17	25x1,50	2400
11x11	1x16	25x1,65	2630
11x12	1 1/16x16	27x1,65	2500
12x12	NA	27x1,85	1700
13x11	1x15	24x1,85	1750
13x15	1 1/4x15	32x1,85	1300
13x18	1 1/2x15	38x1,85	1195
14x15	1 1/4x14	32x2,10	1070
14x18	1 1/2x14	38x2,10	850
14x21	2x14	50x2,10	630
15x15	1 1/4x13	32x2,45	745
15x18	1 1/2x13	38x2,45	695
15x21	2x13	50x2,45	485
15x27	2 1/2x13	63x2,45	390
16x18	1 1/2x12	38x2,80	510
16x21	2x12	50x2,80	375
16x27	2 1/2x12	63x2,80	305
17x21	2x11	50x3,10	295
17x27	2 1/2x11	63x3,10	360
18x21	2x10	50x3,45	230
18x24	2 1/4x10	57x3,45	220
18x27	2 1/2x10	63x3,45	200
18x30	2 3/4x10	70x3,45	180
18x33	3x10	75x3,45	160
18x36	3 1/4x10	82x3,45	140
19x15	1 1/4x9	32x3,90	275
19x27	2 1/2x9	63x3,90	160
19x33	3x9	75x3,90	130
19x36	3 1/4x9	82x3,90	120
19x39	3 1/2x9	89x3,90	110
NA	3x8	75x4,20	110
NA	3 1/2x8	89x4,20	95
20x30	2 3/4x7	70x4,65	115
20x33	3x7	75x4,65	95
20x39	3 1/2x7	89x4,65	80
21x45	4x6	102x5,20	55
22x42	3 3/4x5	95x5,60	50
22x48	4 1/4x5	108x5,60	45
22x54	5x5	129x5,60	40
23x45	4x4	102x6,04	42
23x54	5x4	129x6,04	32
25x72	6 1/2x2	165x7,20	19





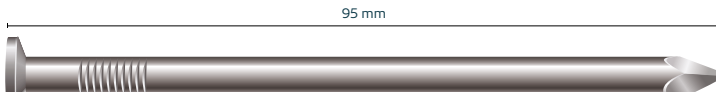
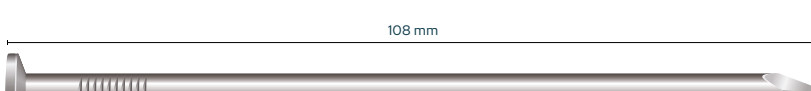
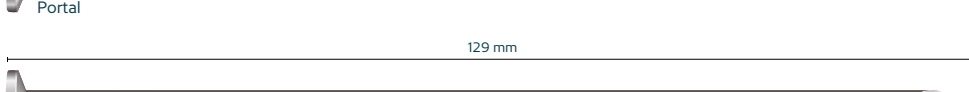
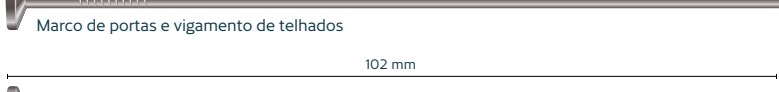
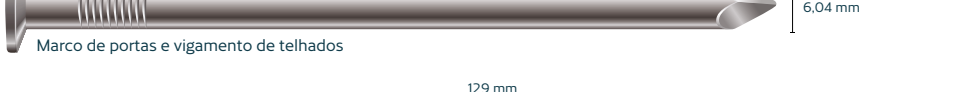



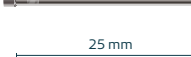

# Pregos com cabeça

JP (Ø) x LPP (h)	POL. (h) x BWG (Ø)	Quant. aprox. em 1 kg	
8x7	5/8x18	5710	 16 mm   1,24 mm Marcenaria e mobiliário
10x9	3/4x17	3640	 19 mm   1,50 mm Embalagens, marcenaria e acabamentos
10x11	1x17	2400	 25 mm   1,50 mm Embalagens, marcenaria e acabamentos
11x11	1x16	2630	 25 mm   1,65 mm Embalagens, marcenaria e acabamentos
11x12	11/16x16	2500	 27 mm   1,65 mm Embalagens, marcenaria e acabamentos
12x12		1700	 27 mm   1,85 mm Caixarias para frutas e verduras
13x11	1x15	1750	 24 mm   1,85 mm Caixarias para frutas e verduras
13x15	11/4x15	1300	 32 mm   1,85 mm Caixarias para frutas e verduras
13x18	11/2x15	1195	 38 mm   1,85 mm Caixarias para frutas e verduras
14x15	11/4x14	1070	 32 mm   2,10 mm Caixarias para frutas e verduras
14x18	11/2x14	850	 38 mm   2,10 mm Caixarias para frutas e verduras
14x21	2x14	630	 50 mm   2,10 mm Caixarias para frutas e verduras
15x15	11/4x13	745	 32 mm   2,45 mm Ripas, telhados e caixarias para frutas e verduras
15x18	11/2x13	695	 38 mm   2,45 mm Ripas, telhados e caixarias para frutas e verduras
15x21	2x13	485	 50 mm   2,45 mm Ripas, telhados e caixarias para frutas e verduras
15x27	2 1/2x13	390	 63 mm   2,45 mm Ripas, telhados e caixarias para frutas e verduras
16x18	11/2x12	510	 38 mm   2,80 mm Lambris e carpintaria
16x21	2x12	375	 50 mm   2,80 mm Lambris e carpintaria
16x27	2 1/2x12	305	 63 mm   2,80 mm Lambris e caixas/fôrmas para concreto











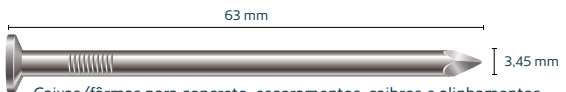

JP (Ø) x LPP (h)	POL. (h) x BWG (Ø)	Quant. aprox. em 1 kg
21x45	4x6	55
22x42	3 3/4x5	50
22x48	4 1/4x5	45
22x54	5x5	40
23x45	4x4	42
23x54	5x4	32
25x72	6 1/2x2	19

 102 mm   5,20 mm Escoramentos, escadas e fechamento de fôrmas
 95 mm   5,60 mm Portal
 108 mm   5,60 mm Portal
 129 mm   5,60 mm Marco de portas e vigamento de telhados
 102 mm   6,04 mm Marco de portas e vigamento de telhados
 129 mm   6,04 mm Mata-burros
 165 mm   7,20 mm Mata-burros e garimpos

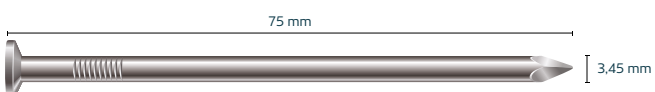
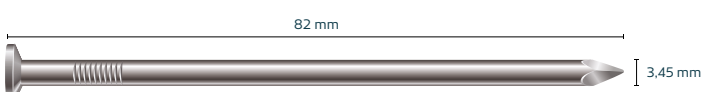
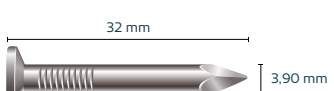
# Pregos sem cabeça

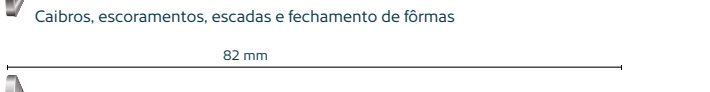
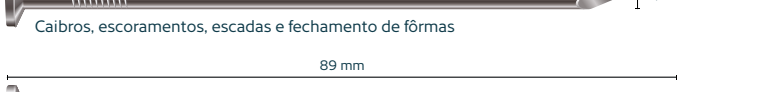
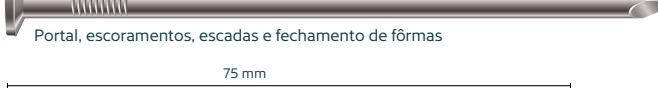

JP (Ø) x LPP (h)	POL. (h) x BWG (Ø)	Quant. aprox. em 1 kg	
8x7	5/8x18	5710	 16 mm   1,24 mm
10x9	3/4x17	3640	 19 mm   1,50 mm
10x11	1x17	2400	 25 mm   1,50 mm
11x11	1x16	2630	 25 mm   1,65 mm
13x11	1x15	1750	 24 mm   1,85 mm
13x15	11/4x15	1300	 32 mm   1,85 mm
13x18	11/2x15	1195	 38 mm   1,85 mm
14x21	2x14	630	 50 mm   2,10 mm
16x21	2x12	375	 50 mm   2,80 mm
16x27	2 1/2x12	305	 63 mm   2,80 mm
21x45	4x6	55	 102 mm   5,20 mm



17x21	2x11	295		50 mm	3,10 mm	Escoramentos, caibros e caixas/fôrmas para concreto
17x27	2 1/2x11	360		63 mm	3,10 mm	Lambris e caixas/fôrmas para concreto
18x21	2x10	230		50 mm	3,45 mm	Escoramentos, caibros e alinhamentos
18x24	2 1/4x10	220		57 mm	3,45 mm	Assoalhos de carrocerias, caixas/fôrmas para concreto, escoramentos e caibros
18x27	2 1/2x10	200		63 mm	3,45 mm	Caixas/fôrmas para concreto, escoramentos, caibros e alinhamentos
18x30	2 3/4x10	180		70 mm	3,45 mm	Escoramentos, caibros e alinhamentos
18x33	3x10	160		75 mm	3,45 mm	Escoramentos, caibros e alinhamentos
18x36	3 1/4x10	140		82 mm	3,45 mm	Escoramentos, caibros e alinhamentos
19x15	1 1/4x9	275		32 mm	3,90 mm	Escoramentos e escadas
19x27	2 1/2x9	160		63 mm	3,90 mm	Caixas/fôrmas para concreto
19x33	3x9	130		75 mm	3,90 mm	Caibros, escoramentos, escadas e fechamento de fôrmas
19x36	3 1/4x9	120		82 mm	3,90 mm	Caibros, escoramentos, escadas e fechamento de fôrmas
19x39	3 1/2x9	110		89 mm	3,90 mm	Portal, escoramentos, escadas e fechamento de fôrmas
	3x8	110		75 mm	4,20 mm	Caibros
	3 1/2x8	95		89 mm	4,20 mm	Caibros
20x30	2 3/4x7	115		70 mm	4,65 mm	Caibros, escoramentos, escadas e fechamento de fôrmas
20x33	3x7	95		75 mm	4,65 mm	Escoramentos, escadas e fechamento de fôrmas
20x39	3 1/2x7	80		89 mm	4,65 mm	Escoramentos, escadas e fechamento de fôrmas

22x48	4 1/4x5	45		108 mm	5,60 mm
-------	---------	----	--	--------	---------

## Pregos galvanizados para telhas

<b>JP x LPP</b>	<b>POL x BWG</b>	
18x27	2 1/2x10	
18x36	3 1/4x10	

## Pregos de duas cabeças

<b>JP x LPP</b>	<b>POL x BWG</b>	
18x27	2 1/2x10	

## Grampos para cerca

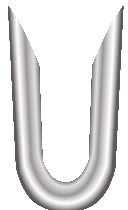
	<b>Galvanizados</b>	<b>Polidos</b>
	9x1" cx. 20 kg	9x1" cx. 20 kg
	9x7/8" cx. 20 kg	9x7/8" cx. 20 kg
	12x7/8" cx. 20 kg	12x7/8" cx. 20 kg

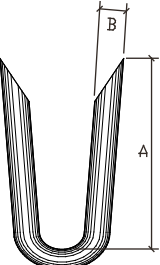
	<b>Dimensões</b>	
	<b>A (BWG)</b>	<b>B (POL)</b>
	9 (3,75mm) x 1 (25,4mm)	
	9 (3,75mm) x 7/8 (22,3mm)	
	12 (2,76mm) x 7/8 (22,3mm)	

Outras dimensões podem ser fornecidas mediante consulta.



## Meio ambiente e sustentabilidade

A Belgo Arames contribui para a preservação do meio ambiente para as futuras gerações adotando práticas sustentáveis, como a gestão das emissões líquidas, sólidas, atmosféricas e o uso racional dos recursos naturais.

lojabelgo.com.br  
belgo.com.br  
0800 727 2000

Acompanhe-nos nas  
redes sociais:



**belgo**  
arames